

# GrasArt



Idee: OK Landschaft, Andreas Kicherer, München



„DAS GRAS WÄCHST NICHT SCHNELLER, WENN MAN DARAN ZIEHT!“ - SPRICHWORT  
„THE GRASS WON'T GROW FASTER IF YOU PULL IT!“ - ADAGE



## »JOSEPHSPLATZ 14« LINSENBUSCH 1 N° 8S-151124-21

### »JOSEPHSPLATZ 14« LINSENBUSCH

- 17 gebogene Edelstahl-Standpfosten
- 17 curved posts made of stainless steel
- 10 Halteseile
- 10 safety ropes
- 4 schwebende Gummisitzflächen
- 4 hovering rubber seats
- horizontale Seilleiter mit Edelstahl-Trittunterstützung
- horizontal rope-ladder with step support made of stainless steel

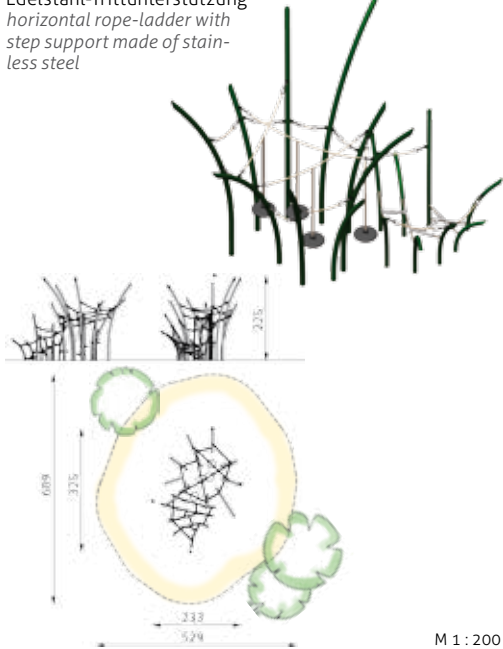

PREISLISTE	FALLSCHUTZBEREICH	MAX. HÖHE	FUNDAMENTE
€ Price List P.13	Protective Area 529 x 609 cm	Free Fall 165 cm	Basement gemäß Statik
ALTER	MONTAGE	GEWICHT	
Age 4-8	Field Installation 4 Monteure je 16h	Weight 1000 kg 300 kg	

## »JOSEPHSPLATZ 5« LINSENBUSCH 2 N° 8S-150310-25

### »JOSEPHSPLATZ 5« LINSENBUSCH

- 17 gebogene Edelstahl-Standpfosten
- 17 curved posts made of stainless steel
- 14 Halteseile
- 14 safety ropes
- 3 horizontale, ovale Kletternetze
- 3 horizontal, oval climbing nets
- 4 Aufstiegshilfen aus Gummi
- 4 rubber steps

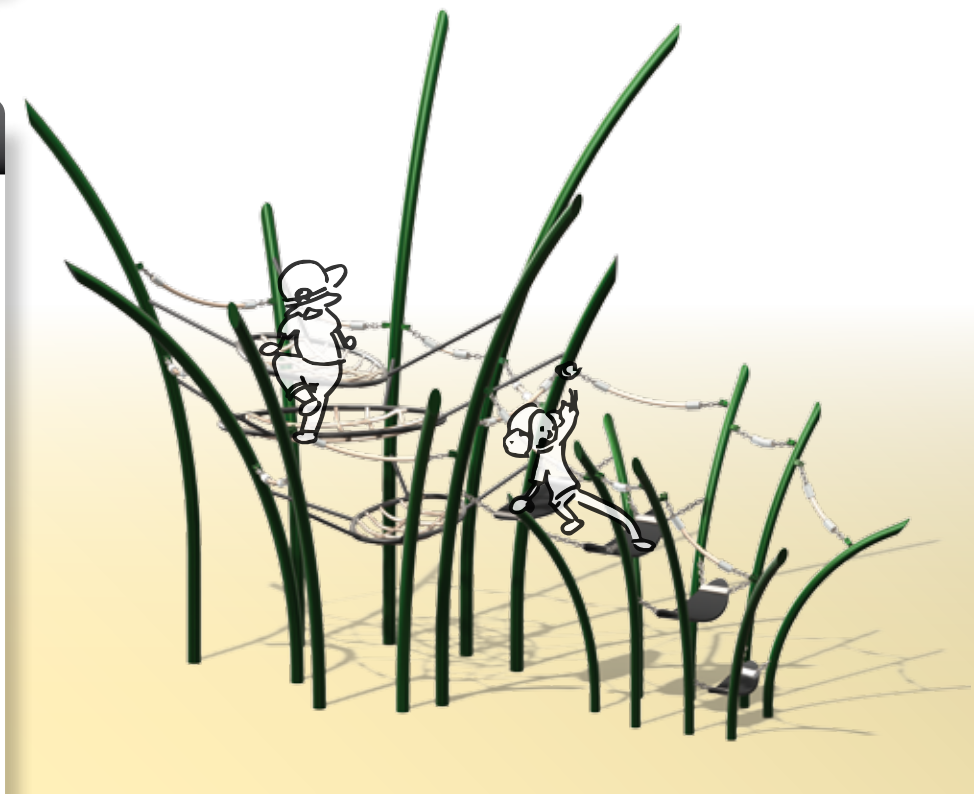
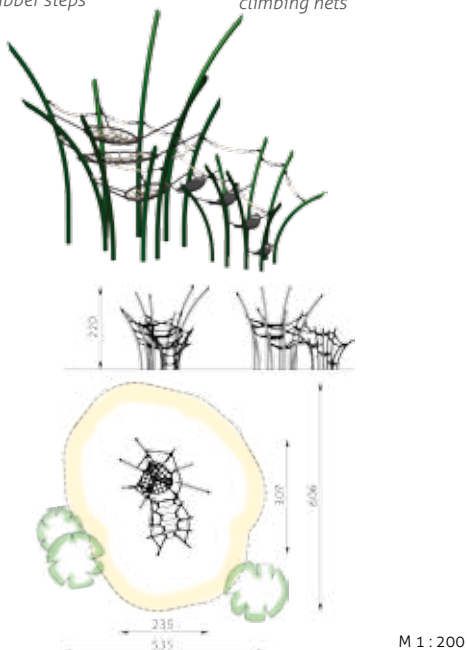

PREISLISTE	FALLSCHUTZBEREICH	MAX. HÖHE	FUNDAMENTE
€ Price List P.13	Protective Area 535 x 606 cm	Free Fall 150 cm	Basement gemäß Statik
ALTER	MONTAGE	GEWICHT	
Age 4-8	Field Installation 4 Monteure je 16h	Weight 1000 kg 300 kg	

## »JOSEPHSPLATZ 1B« TUNNELBUSCH N° 8S-151125-21

### »JOSEPHSPLATZ 1B« TUNNELBUSCH

28 gebogene Edelstahl-  
Standpfosten  
28 curved posts made of  
stainless steel

4 Aufstiegshilfen aus Gummi  
4 rubber steps

5 Halteseile  
5 safety ropes

Aufstiegsnetz in Rautenform  
rhombus shaped climbing net

vertikaler Netztunnel  
vertical net tunnel

Spinnennetz  
spider net

diverse kurze Kletterseile  
various short climbing ropes

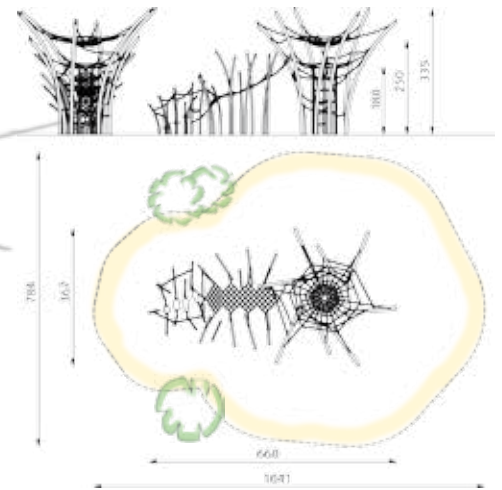

M 1 : 200

## »JOSEPHSPLATZ 2« SESSELBUSCH N° 8S-150310-22

### »JOSEPHSPLATZ 2« SESSELBUSCH

20 gebogene Edelstahl-  
Standpfosten  
20 curved posts made of  
stainless steel

horizontale Seil-Leiter  
horizontal rope ladder

3 Halteseile  
3 safety ropes

2 Gummi-Sitzflächen  
2 rubber seats

17 Kletterseile  
17 climbing ropes

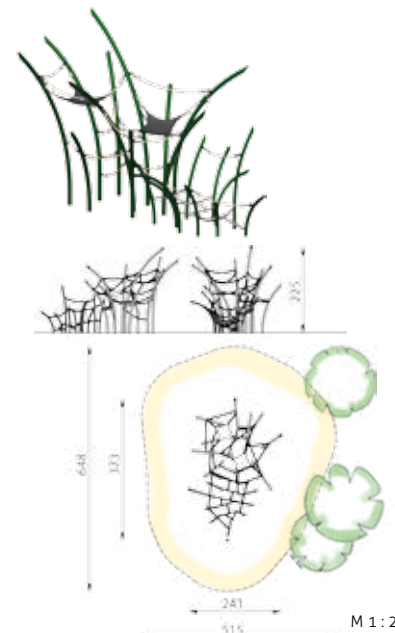

M 1 : 200



PREISLISTE	FALLSCHUTZBEREICH	MAX. HÖHE	FUNDAMENTE
Price List <b>P.13</b>	Protective Area <b>784 x 1041 cm</b>	Free Fall <b>300 cm</b>	Basement gemäß Statik
ALTER	MONTAGE	GEWICHT	
Age <b>4-8</b>	Field Installation <b>4 Monteure je 16h</b>	Weight <b>1200 kg 300 kg</b>	

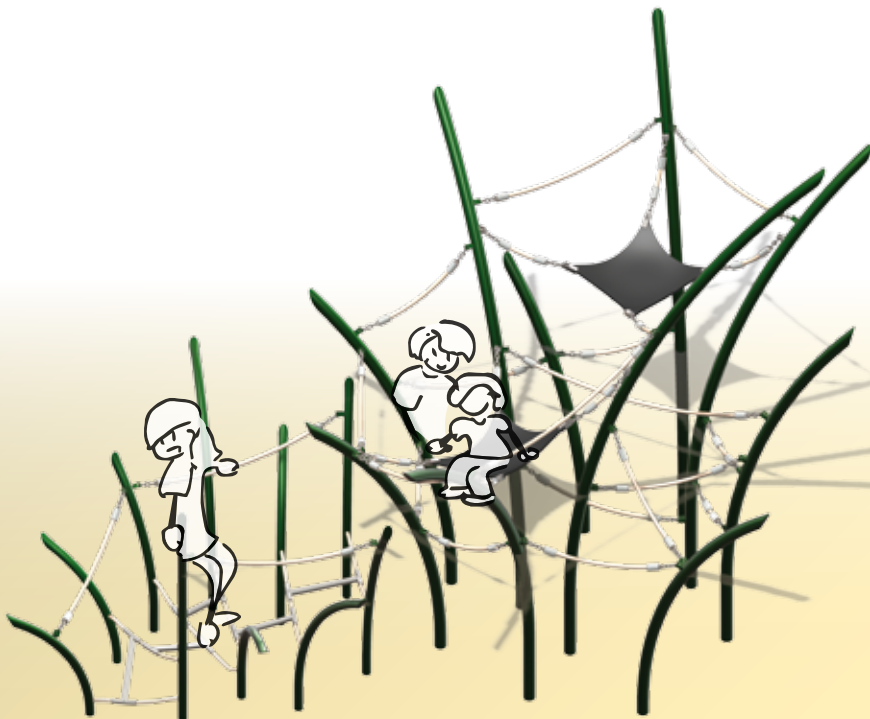

PREISLISTE	FALLSCHUTZBEREICH	MAX. HÖHE	FUNDAMENTE
Price List <b>P.13</b>	Protective Area <b>515 x 648 cm</b>	Free Fall <b>165 cm</b>	Basement gemäß Statik
ALTER	MONTAGE	GEWICHT	
Age <b>4-8</b>	Field Installation <b>3 Monteure je 16h</b>	Weight <b>1000 kg 300 kg</b>	



»JOSEPHSPLATZ 14« - N° 85-151125-21

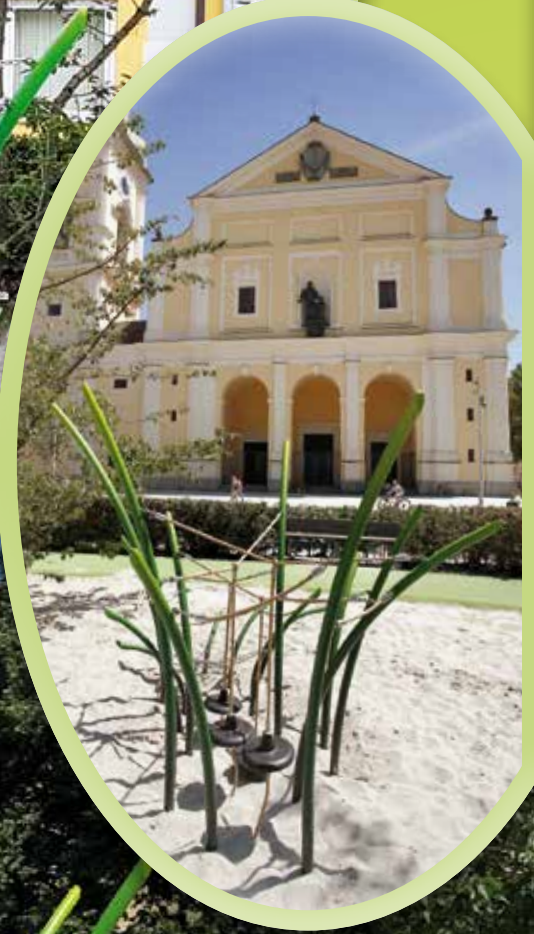

»JOSEPHSPLATZ 1B« - N° 85-151125-21

»JOSEPHSPLATZ 14« - N° 85-151125-21

»JOSEPHSPLATZ 1B« - N° 85-151125-21





## »JOSEPHSPLATZ 3« SCHOTENPFLANZE - N° 85-141204-26

### »JOSEPHSPLATZ 3« SCHOTENPFLANZE

32 gebogene Edelstahl-  
Standpfosten  
32 curved posts made of  
stainless steel

2 geneigte Spinnennetze  
2 inclined spider nets

16 Halteseile  
16 safety ropes

7 Kletter-/Halteseile  
7 safety-/climbing ropes

Edelstahl-Muldenrutsche mit  
Kurve / stainless steel slide,  
u-shaped, curved

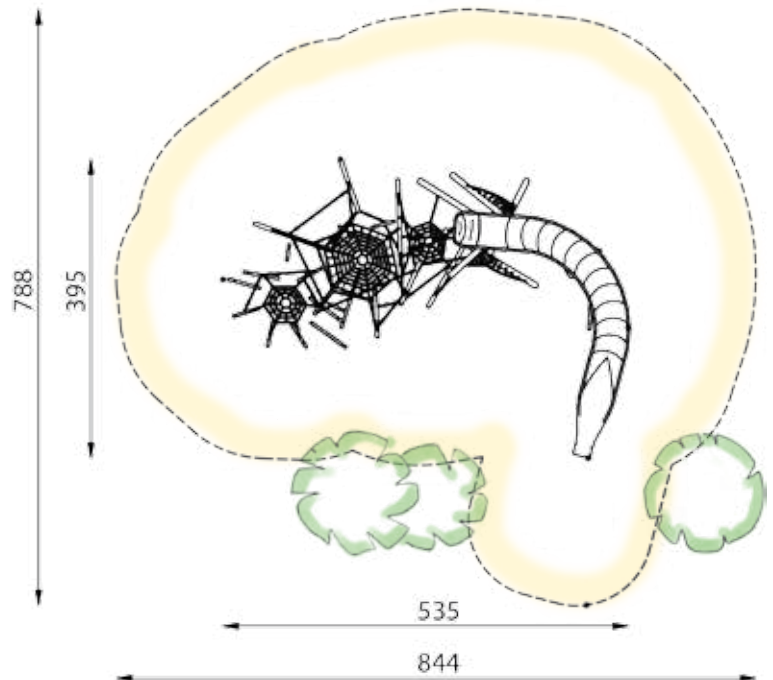

M 1 : 100

PREISLISTE	ALTER	FALLSCHUTZBEREICH	MAX. HÖHE	GEWICHT	MONTAGE	FUNDAMENTE
€ Price List P.13	🦉 Age 4-10	🦉 Protective Area 788 x 844 cm	🦉 Free Fall 300 cm	🦉 Weight 1000 kg / 350 kg	🦉 Field Installation 4 Monteure je 24h	🦉 Basement gemäß Statik

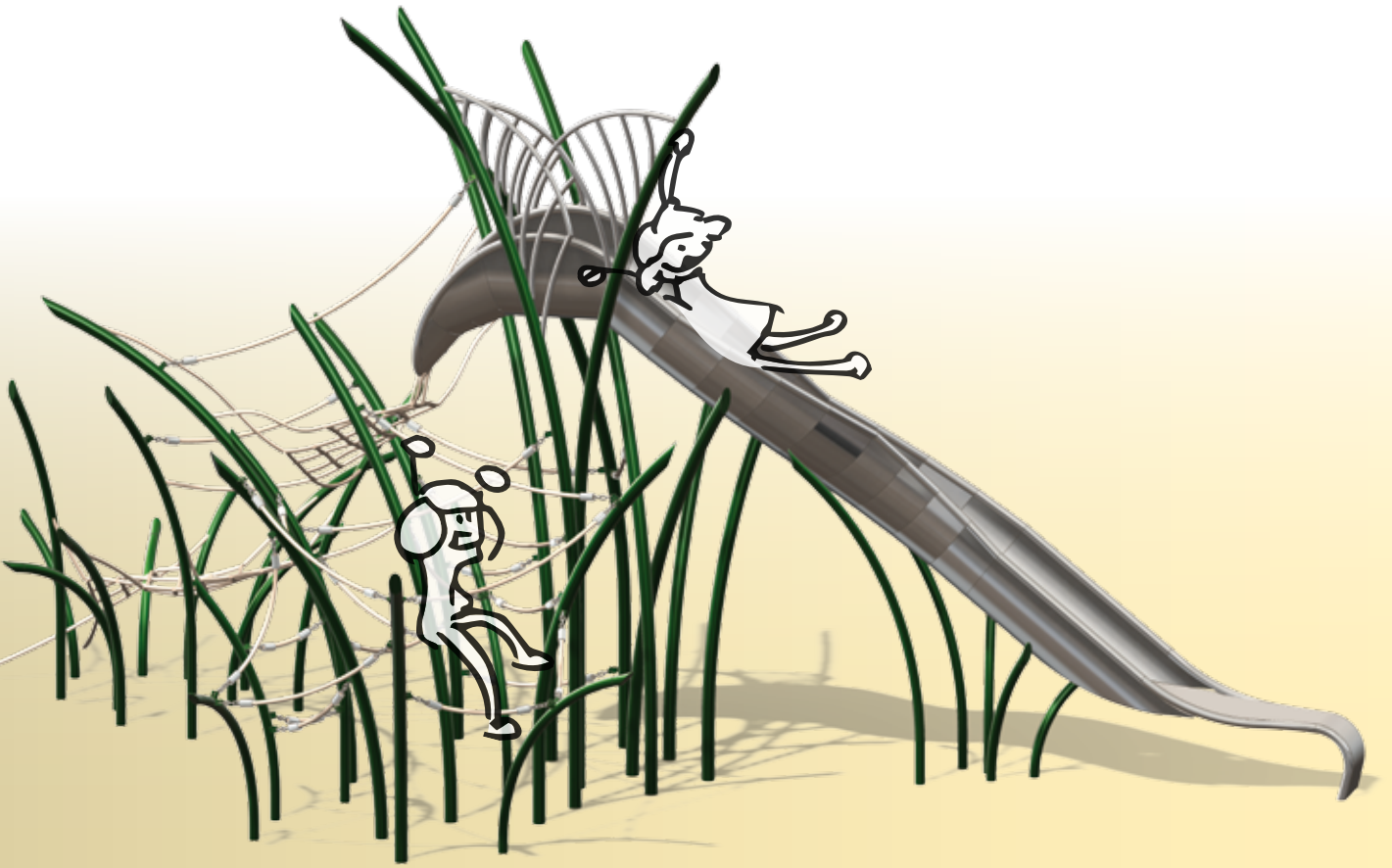

»JOSEPHSPLATZ 9B« SCHOTENSTRAUCH - N° 8S-150304-21

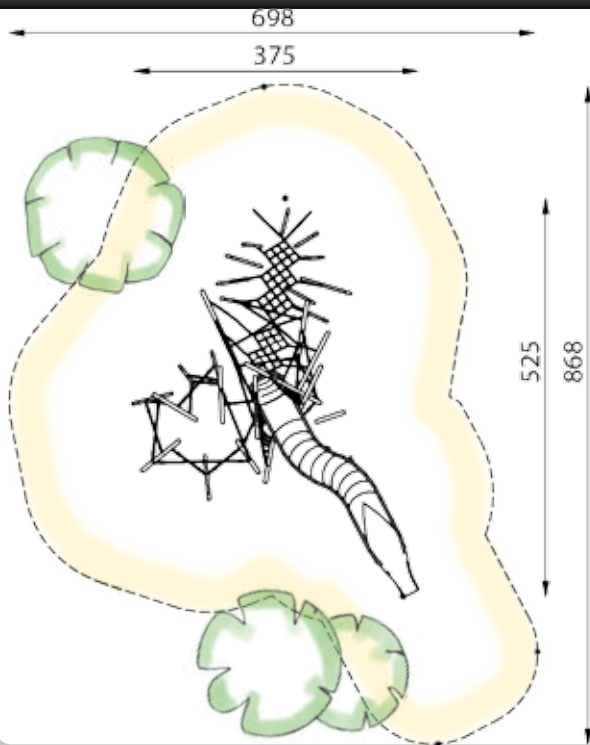

»JOSEPHSPLATZ 9B« SCHOTENSTRAUCH

33 gebogene Edelstahl-  
Standpfosten  
33 curved posts made of  
stainless steel  
Aufstiegsnetz in Rautenform  
rhombus shaped climbing net

22 Kletter- und Halteseile  
22 climbing- and safety ropes  
Netz in Rautenform  
rhombus shaped net  
Edelstahl-Muldenrutsche  
mit 2 Kurven / stainless steel  
slide, u-shaped, with 2 curves

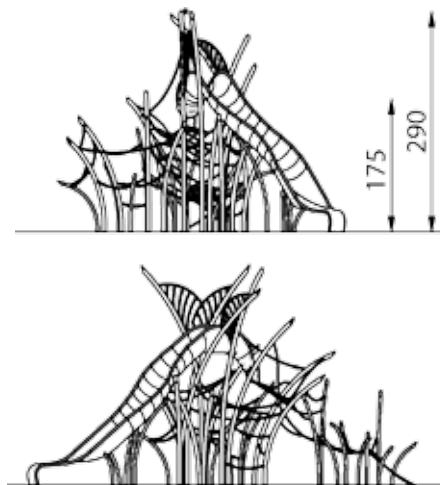

M 1 : 100

PREISLISTE	ALTER	FALLSCHUTZBEREICH	MAX. HÖHE	GEWICHT	MONTAGE	FUNDAMENTE
Price List P.13	Age 4-8	Protective Area 698 x 868 cm	Free Fall 180 cm	Weight 1500 kg 350 kg	Field Installation 4 Monteure je 24h	Basement gemäß Statik



»JOSEPHSPLATZ 3« - N° 85-141204-26



»JOSEPHSPLATZ 9B« - N° 85-150304-21

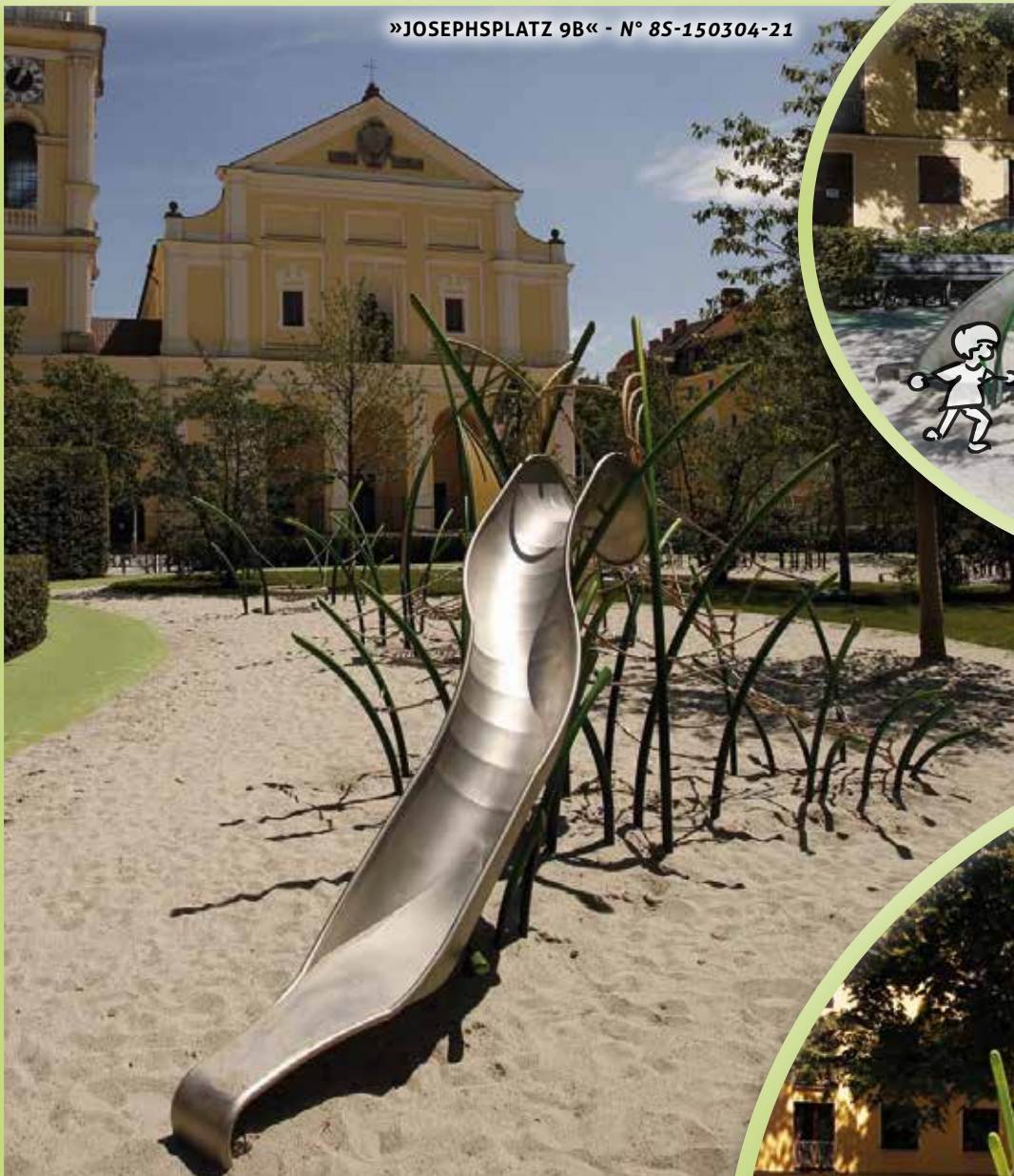



»JOSEPHSPLATZ 13« KLETTERPFLANZE - N° 8S-151016-22

»JOSEPHSPLATZ 13« KLETTERPFLANZE

27 gebogene Edelstahl-  
Standpfosten  
27 curved posts made of  
stainless steel

4 Lochbleche mit Wabenlo-  
chung bilden 2 Kokons  
4 metal sheets with  
honeycomb punching  
form 2 cocoons

2 horizontale Fünfecknetze  
2 horizontal pentagon nets

5 Halteseile  
5 safety ropes

Seillabyrinth mit 30 Seilen  
rope labyrinth with 30 ropes



348



648

432

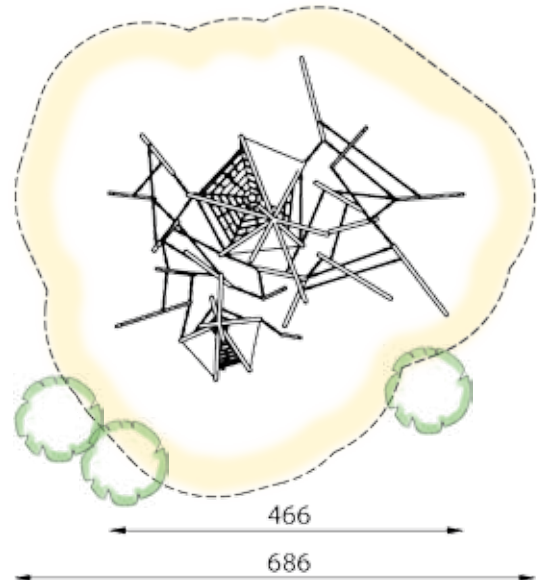

466

686

M 1 : 100

PREISLISTE	ALTER	FALLSCHUTZBEREICH	MAX. HÖHE	GEWICHT	MONTAGE	FUNDAMENTE
€ Price List P.13	🦉 Age 4-8	🦉 Protective Area 648 x 686 cm	🦉 Free Fall 130 cm	🦉 Weight 1000 kg 250 kg	🦉 Field Installation 3 Monteure je 16h	🦉 Basement gemäß Statik

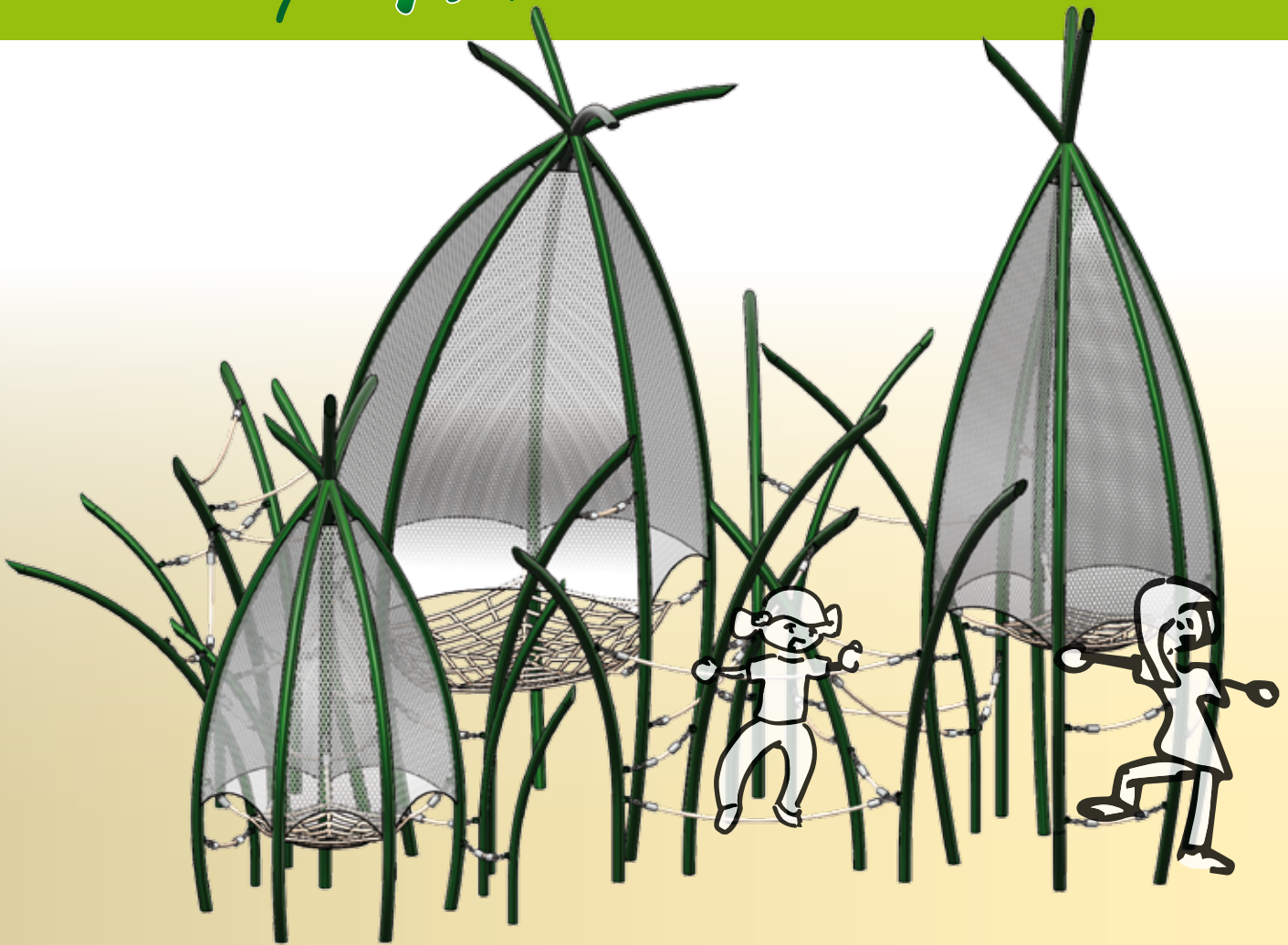

## »JOSEPHSPLATZ 12« KOKON - N° 85-150727-21

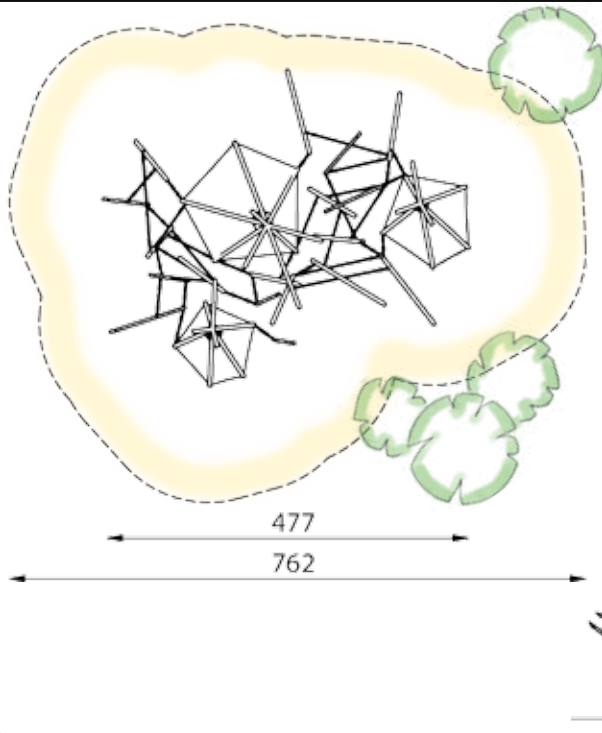

### »JOSEPHSPLATZ 12« KOKON

33 gebogene Edelstahl-  
Standpfosten  
33 curved posts made of  
stainless steel  
15 Lochbleche mit Wabenlo-  
chung bilden 3 Kokons  
15 metal sheets with  
honeycomb punching  
form 3 cocoons

3 horizontale Fünfecknetze  
3 horizontal pentagon nets  
diverse Halteseile  
several safety ropes  
Seillabyrinth  
rope labyrinth

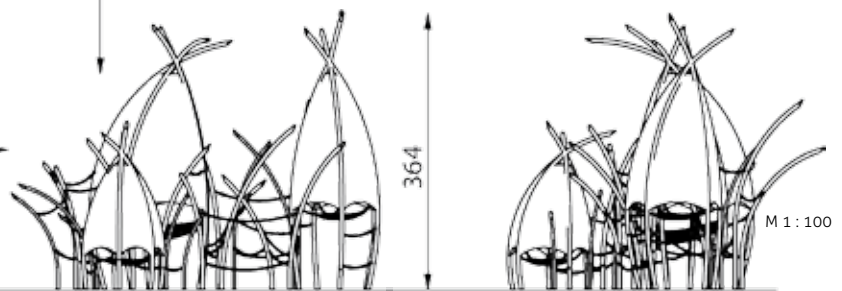

PREISLISTE	ALTER	FALLSCHUTZBEREICH	MAX. HÖHE	GEWICHT	MONTAGE	FUNDAMENTE
€ Price List P.13	Age 4-9	Protective Area 627 x 762 cm	Free Fall 130 cm	Weight 1100 kg / 300 kg	Field Installation 3 Monteure je 16h	Basement gemäß Statik

»JOSEPHSPLATZ« IN MÜNCHEN



GRASLANDSCHAFT »ESSEN« - N° 8S-170201-41



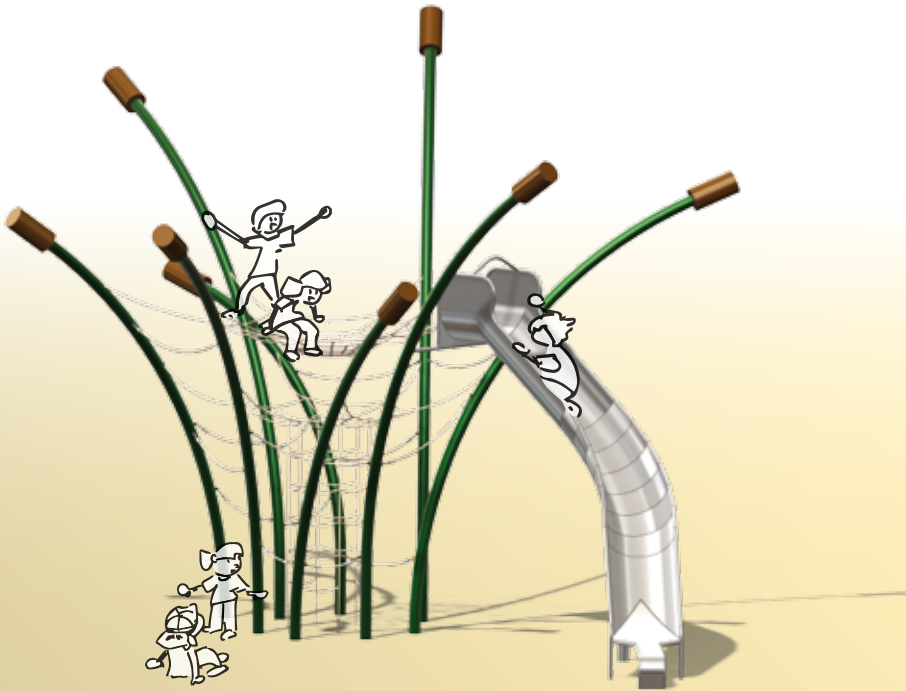

## GRASLANDSCHAFT »KOPERNIKUS II« N° 8S-170123-51

### GRASS LANDSCAPE »KOPERNIKUS II«

8 gebogene Edelstahl-Standpfosten mit Rohrkolben als Abschluss  
8 curved posts made of stainless steel with tube piston endings

horizontales Spinnennetz  
horizontal spider net

diverse Kletterseile  
various climbing ropes

Edelstahl-Muldenrutsche mit Kurve / stainless steel slide, u-shaped, curved

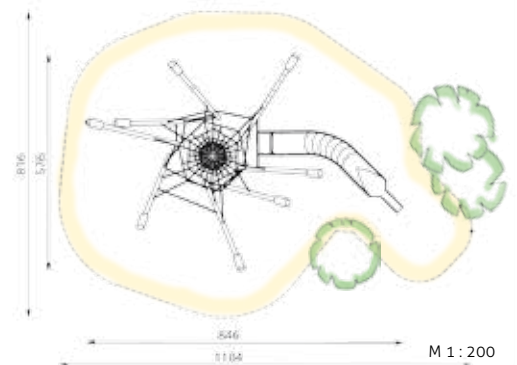

PREISLISTE	FALLSCHUTZBEREICH	MAX. HÖHE	FUNDAMENTE
Price List <b>P.13</b>	Protective Area <b>816 x 1104 cm</b>	Free Fall <b>300 cm</b>	Basement gemäß Statik
<b>ALTER</b>	<b>MONTAGE</b>	<b>GEWICHT</b>	
Age <b>4-8</b>	Field Installation <b>3 Monteure je 8h</b>	Weight <b>600 kg / 250 kg</b>	

## »SEILWAND« - N° 7S-170222-42

### »ROPE WALL«

2 Edelstahl-Standpfosten  
2 posts made of stainless steel

Edelstahl-Querträger  
horizontal beam made of stainless steel

7 Seile  
7 ropes

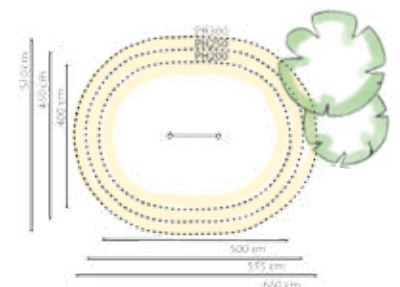

PREISLISTE	FALLSCHUTZBEREICH	MAX. HÖHE	FUNDAMENTE
Price List <b>P.13</b>	Protective Area <b>max. 510 x 650 cm</b>	Free Fall <b>300 cm</b>	Basement gemäß Statik
<b>ALTER</b>	<b>MONTAGE</b>	<b>GEWICHT</b>	
Age <b>4-10</b>	Field Installation <b>2 Monteure je 2h</b>	Weight <b>100 kg / 30 kg</b>	

## »WACHTURM IM MOOR« N° 1.0020-161209-41

### »WATCHTOWER IN SWAMP«

- Achteckplattform / Octagon platform
- 8 gebogene Edelstahl-Standpfosten  
8 curved posts made of stainless steel
- 3 Edelstahl-Druckstützen  
3 pressure support posts made of stainless steel
- Edelstahl-Absturzicherungen  
safety harness made of stainless steel
- Netztunnel / net tunnel
- Kletterwand / climbing wall
- Leiter / ladder
- Flächennetz / horizontal net
- Kunstreedach / synthetic thatched roof
- Edelstahl-Kastenrutsche  
stainless steel slide, box shaped
- 11 gebogene Edelstahl-Standpfosten  
11 curved posts made of stainless steel
- 2 Figuren „Rabe“ aus Eiche  
2 figures "raven" made of oak
- Hängematte / hammock
- diverse Kletterseile  
various climbing ropes
- Lauf- und Halteseil  
rope with safety rope
- 5 Holz-Balancierbalken  
5 wooden logs

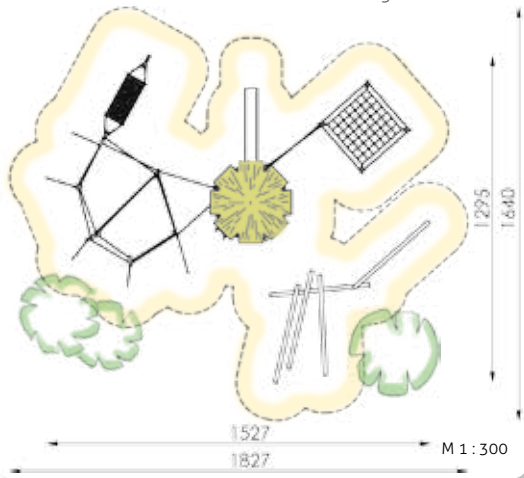

PREISLISTE	FALLSCHUTZBEREICH	MAX. HÖHE	FUNDAMENTE
€ Price List <b>P.13</b>	Protective Area <b>1640 x 1827 cm</b>	Free Fall <b>250 cm</b>	Basement gemäß Statik
ALTER	MONTAGE	GEWICHT	
Age <b>6-12</b>	Field Installation <b>4 Monteure je 18h</b>	Weight <b>1200 kg 200 kg</b>	



## »GRASSPINNE« - N° 75-170214-41

### »GRASS SPIDER«

- 8 gebogene Edelstahl-Standpfosten  
8 curved posts made of stainless steel
- Flächennetz  
horizontal net
- Netzaufstieg  
climbing net
- Seillabyrinth mit diversen Seilen  
rope labyrinth with various ropes
- 4 Aussteifungen aus gebogenem Edelstahlrohr  
4 bracings made of curved stainless steel

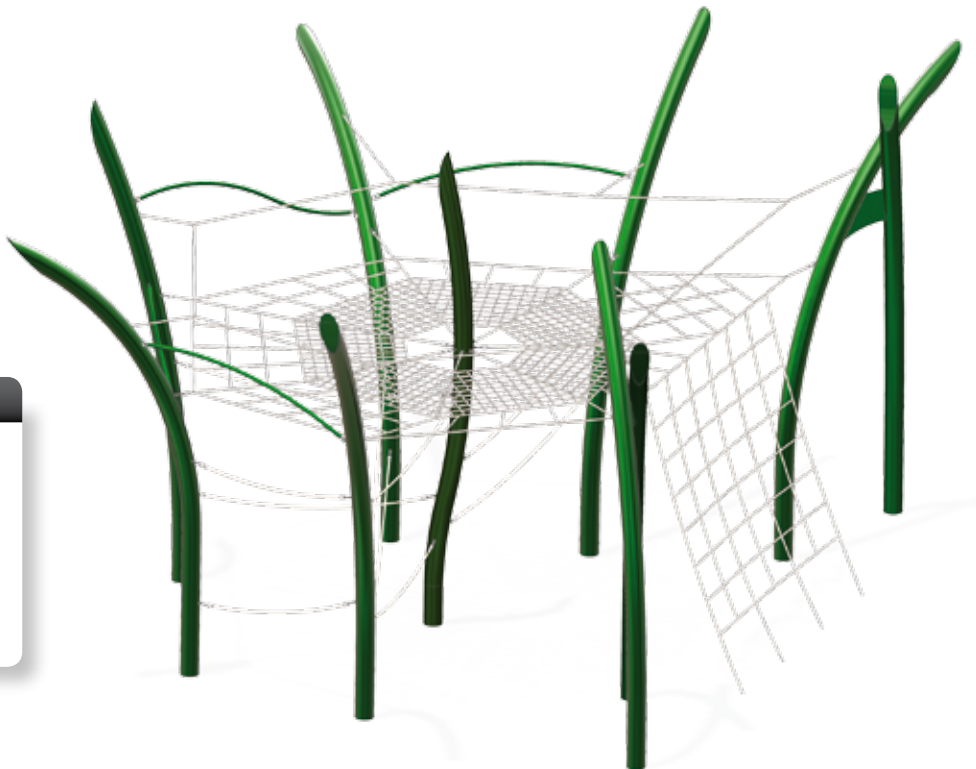

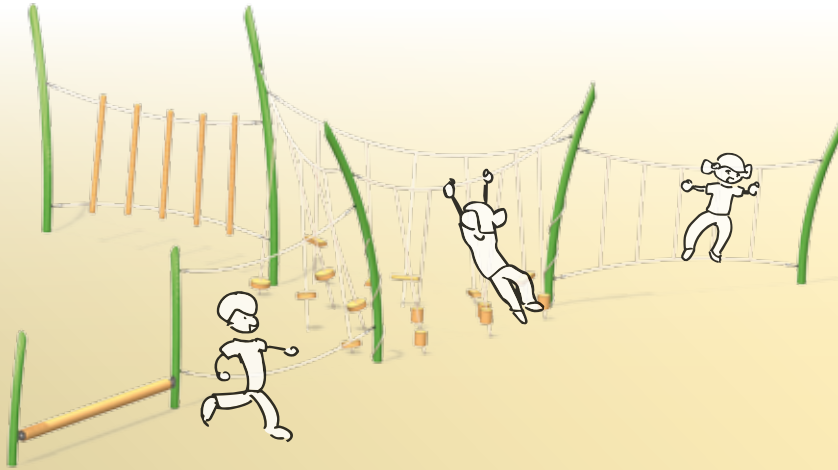

## »LIANENPFAD« - N° 7S-170213-46

### »LIANA PATH«

7 gebogene Edelstahl-  
Standpfosten  
7 curved posts made of  
stainless steel

3 Edelstahl-Seile / 3 ropes  
made of stainless steel

Drehbalken aus Robinie  
turnable log

Lauf- und Halteseil  
rope with safety rope

Seilharfe / rope harp

Holzharfe / wooden harp

18 Seile / 18 ropes

9 Balancierteller  
9 balance plates

5 senkrechte Seile  
5 vertical ropes

5 Balancierklötze  
5 balance blocks

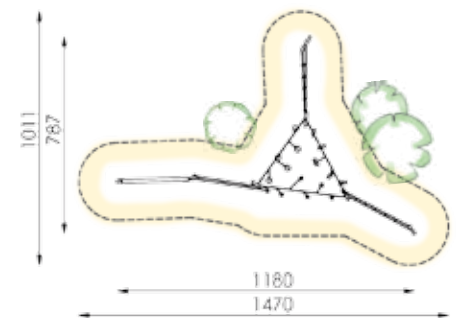

M 1 : 300

PREISLISTE	FALLSCHUTZBEREICH	MAX. HÖHE	FUNDAMENTE
Price List <b>P.13</b>	Protective Area <b>1011 x 1470 cm</b>	Free Fall <b>150 cm</b>	Basement <b>gemäß Statik</b>
ALTER	MONTAGE	GEWICHT	
Age <b>5-12</b>	Field Installation <b>3 Monteure je 16h</b>	Weight <b>850 kg 80 kg</b>	

## »LIANENPFAD II« - N° 7S-170308-44

### »LIANA PATH II«

5 gebogene Edelstahl-  
Standpfosten  
5 curved posts made of  
stainless steel

3 Edelstahl-Seile / 3 ropes  
made of stainless steel

Drehbalken aus Robinie  
turnable log

Holzharfe / wooden harp

diverse Seile / various ropes

7-9 Balancierteller  
7-9 balance plates

4-5 Balancierklötze  
4-5 balance blocks

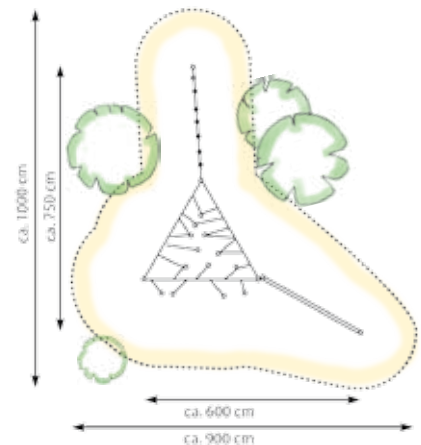

M 1 : 200

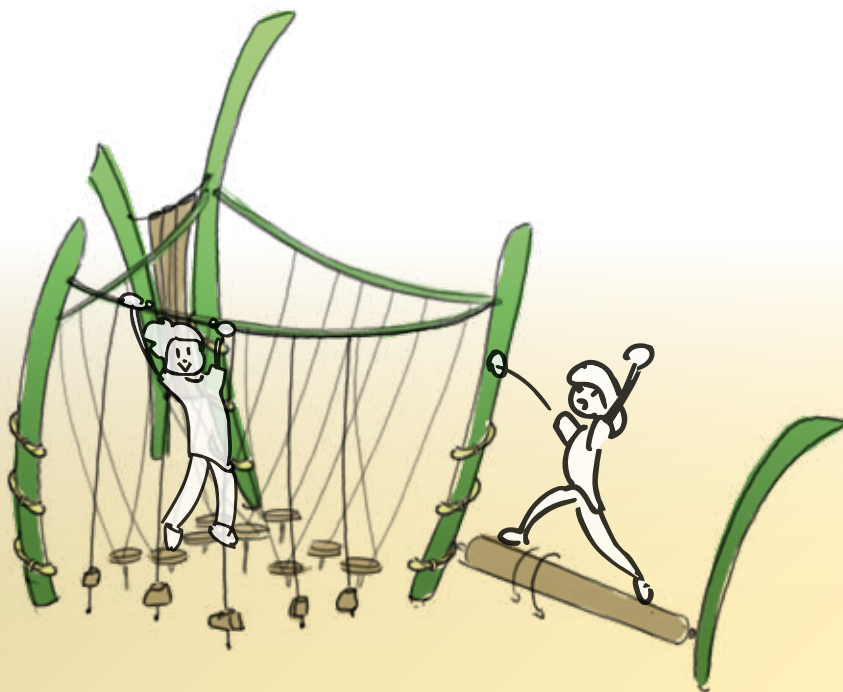

PREISLISTE	FALLSCHUTZBEREICH	MAX. HÖHE	FUNDAMENTE
Price List <b>P.13</b>	Protective Area <b>ca. 750 x 900 cm</b>	Free Fall <b>150 cm</b>	Basement <b>gemäß Statik</b>
ALTER	MONTAGE	GEWICHT	
Age <b>5-12</b>	Field Installation <b>2 Monteure je 8h</b>	Weight <b>550 kg 80 kg</b>	



»GRASLANDSCHAFT MEDIAPARK« - N° SK-170927-41





**GRASLANDSCHAFT »RIESTE«**  
N° 8S-161214-41

**GRASS LANDSCAPE »RIESTE«**

8 gebogene Edelstahl-  
Standpfosten mit  
Rohrkolben als Abschluss  
8 curved posts made of  
stainless steel with  
tube piston endings

18 gebogene Edelstahl-  
Standpfosten  
18 curved posts made of  
stainless steel

4 elliptische Gummisitz-  
flächen  
4 elliptical rubber seats

4 Kletternetze  
4 climbing nets

diverse Kletterseile  
various climbing ropes

Spinnennetz mit Netztunnel  
spider net with net tunnel

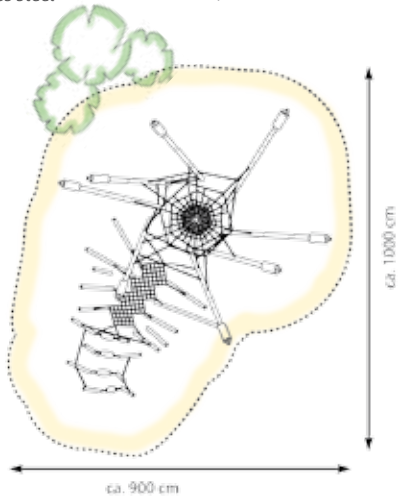

PREISLISTE	FALLSCHUTZBEREICH	MAX. HÖHE	FUNDAMENTE
€ Price List <b>P.13</b>	Protective Area ca. 900 x 1000 cm	Free Fall <b>300 cm</b>	Basement gemäß Statik
ALTER	MONTAGE	GEWICHT	
Age <b>4-8</b>	Field Installation <b>4 Monteure je 16h</b>	Weight <b>850 kg 120 kg</b>	

**GRASLANDSCHAFT »ESSEN«**  
N° 8S-170201-41

**GRASS LANDSCAPE »ESSEN«**

8 gebogene Edelstahl-  
Standpfosten mit  
Rohrkolben als Abschluss  
8 curved posts made of  
stainless steel with  
tube piston endings

18 gebogene Edelstahl-  
Standpfosten  
18 curved posts made of  
stainless steel

Edelstahl-Muldenrutsche  
mit Kurve / stainless steel  
slide, u-shaped

4 elliptische Gummisitz-  
flächen  
4 elliptical rubber seats

4 Kletternetze  
4 climbing nets

Spinnennetz mit Netztunnel  
spider net with net tunnel

diverse Kletterseile  
various climbing ropes

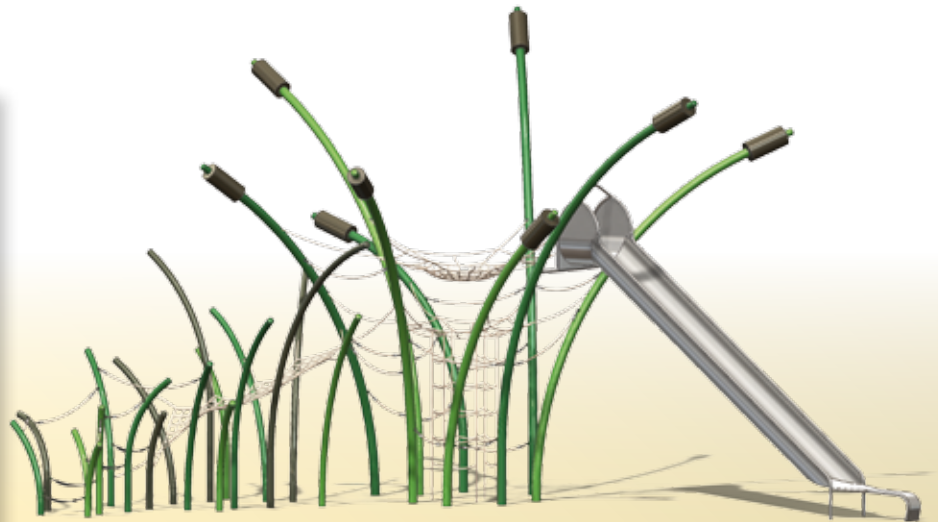
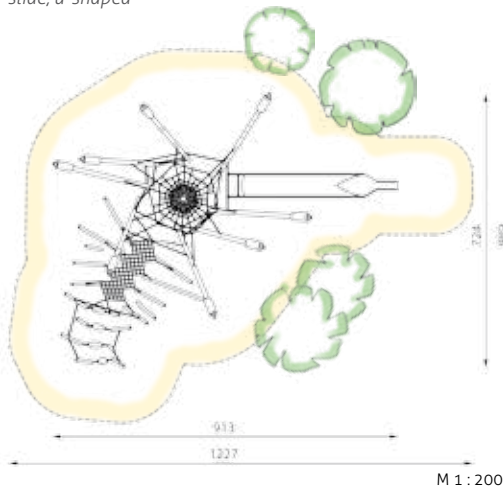

PREISLISTE	FALLSCHUTZBEREICH	MAX. HÖHE	FUNDAMENTE
€ Price List <b>P.13</b>	Protective Area <b>989 x 1227 cm</b>	Free Fall <b>300 cm</b>	Basement gemäß Statik
ALTER	MONTAGE	GEWICHT	
Age <b>4-8</b>	Field Installation <b>4 Monteure je 16h</b>	Weight <b>1000 kg 120 kg</b>	



## »BAUMSPIRALE« - N° 7S-170221-42

### »TREE SPIRAL«

8-12 Edelstahl-Standpfosten  
 8-12 posts made of stainless steel  
 spiralförmige Rampe, mit Edelstahl umschlossen  
 spiral ramp enclosed by stainless steel  
 3 Durchstiegsöffnungen aus Edelstahl-Lochblech  
 3 openings made of perforated stainless steel plates

Rampe mit Halteseil  
 ramp with safety rope  
 Strickleiter mit Edelstahlsprossen / rope ladder with stainless steel bars  
 Edelstahl-Tunnelrutsche  
 stainless steel tunnel slide

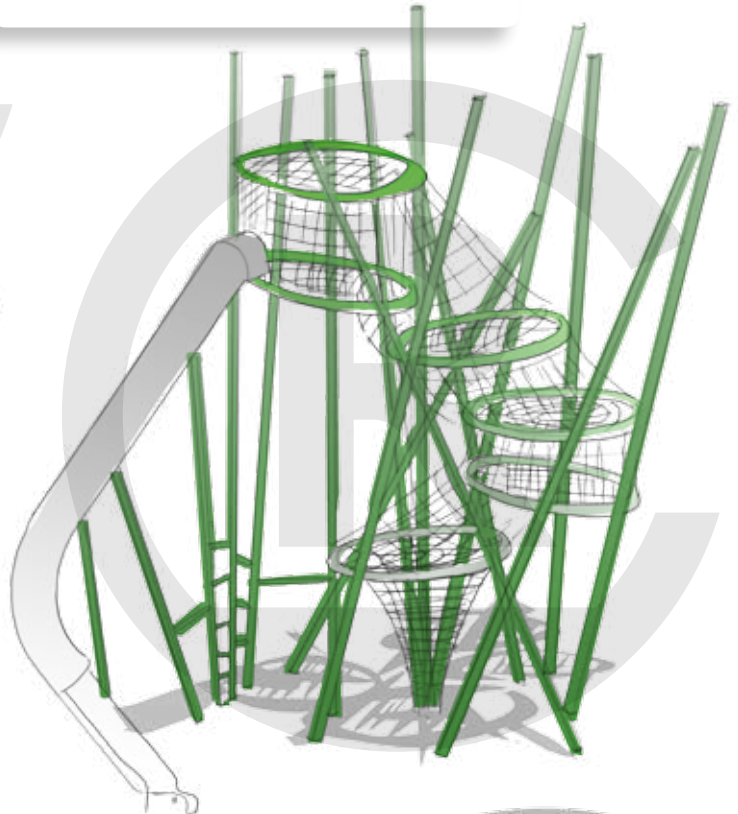

## KLETTERKOMBI »LAYERS« - N° 7S-170221-43

### CLIMBING COMBINATION »LAYERS«

16 Edelstahl-Standpfosten 16 posts made of stainless steel	Netztunnel net tunnel
6 geneigte Edelstahlringe 6 inclined rings made of stainless steel	Edelstahl-Tunnelrutsche mit Kurve stainless steel tunnel slide, curved
5 Netzböden 5 floors made of nets	

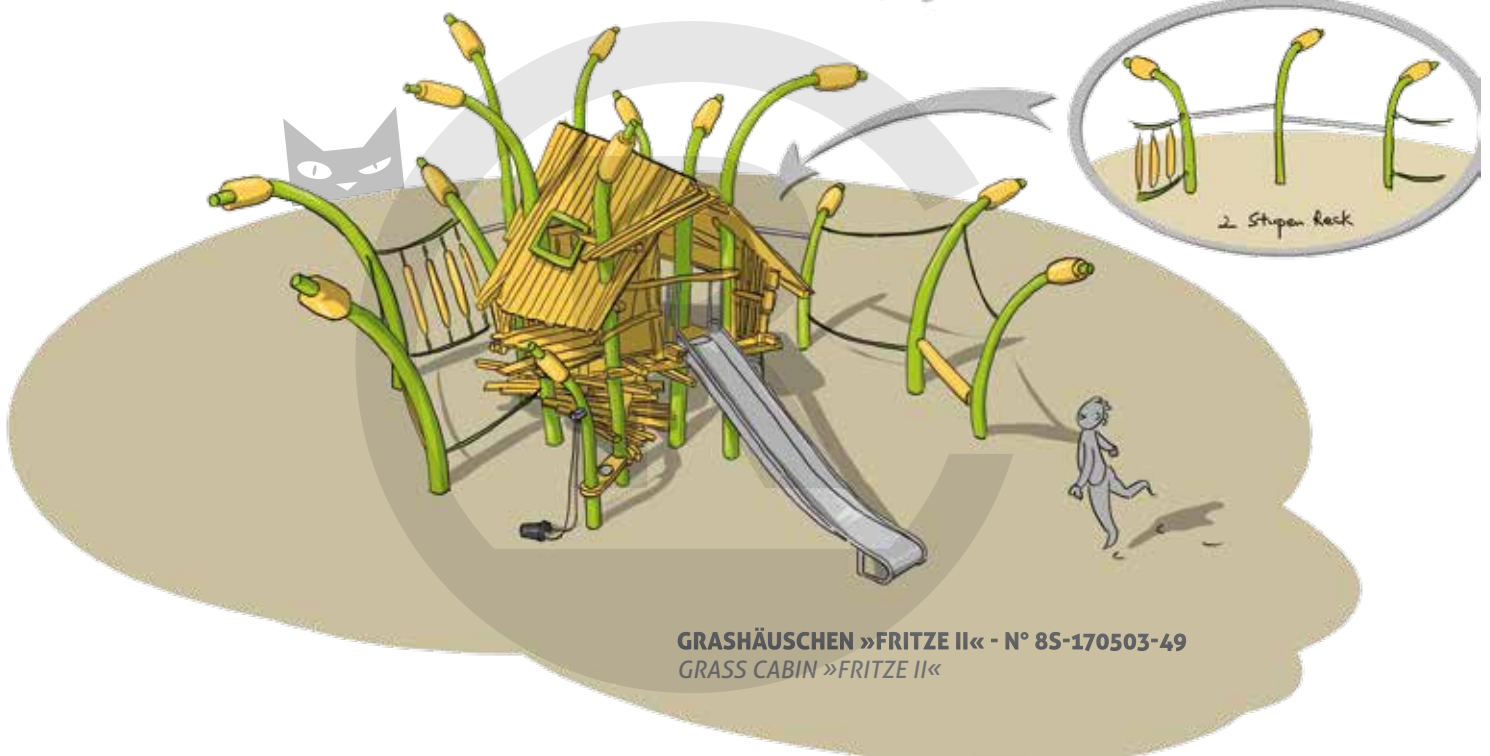

## GRASHÄUSCHEN »FRITZE II« - N° 8S-170503-49 GRASS CABIN »FRITZE II«



»JOSEPHSPLATZ 15« - N° 6S-151126-21

»JOSEPHSPLATZ 13« - N° 85-151016-22



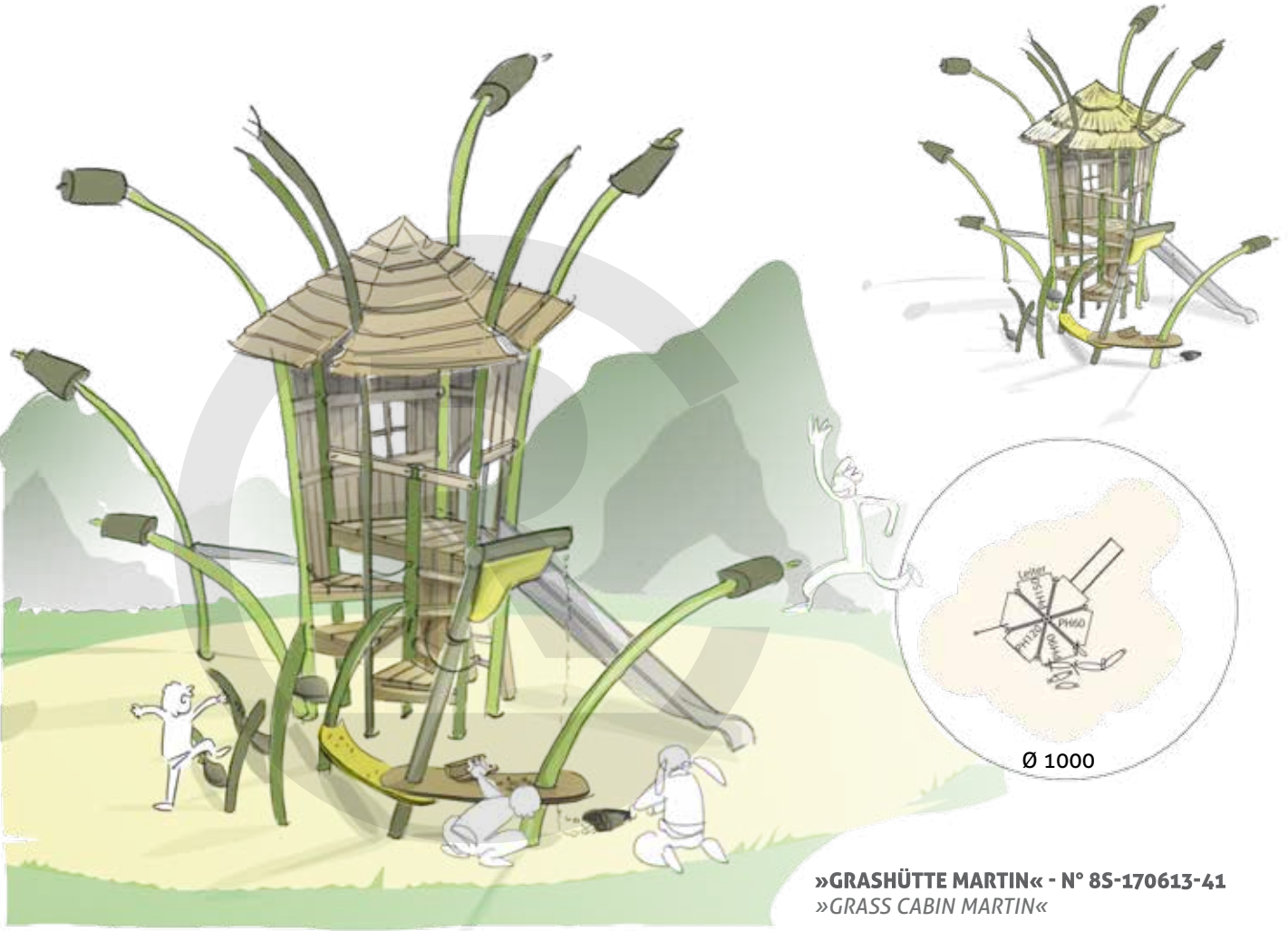

»GRASHÜTTE MARTIN« - N° 8S-170613-41  
»GRASS CABIN MARTIN«

**GRASBÄNKE - SIT DOWN!**

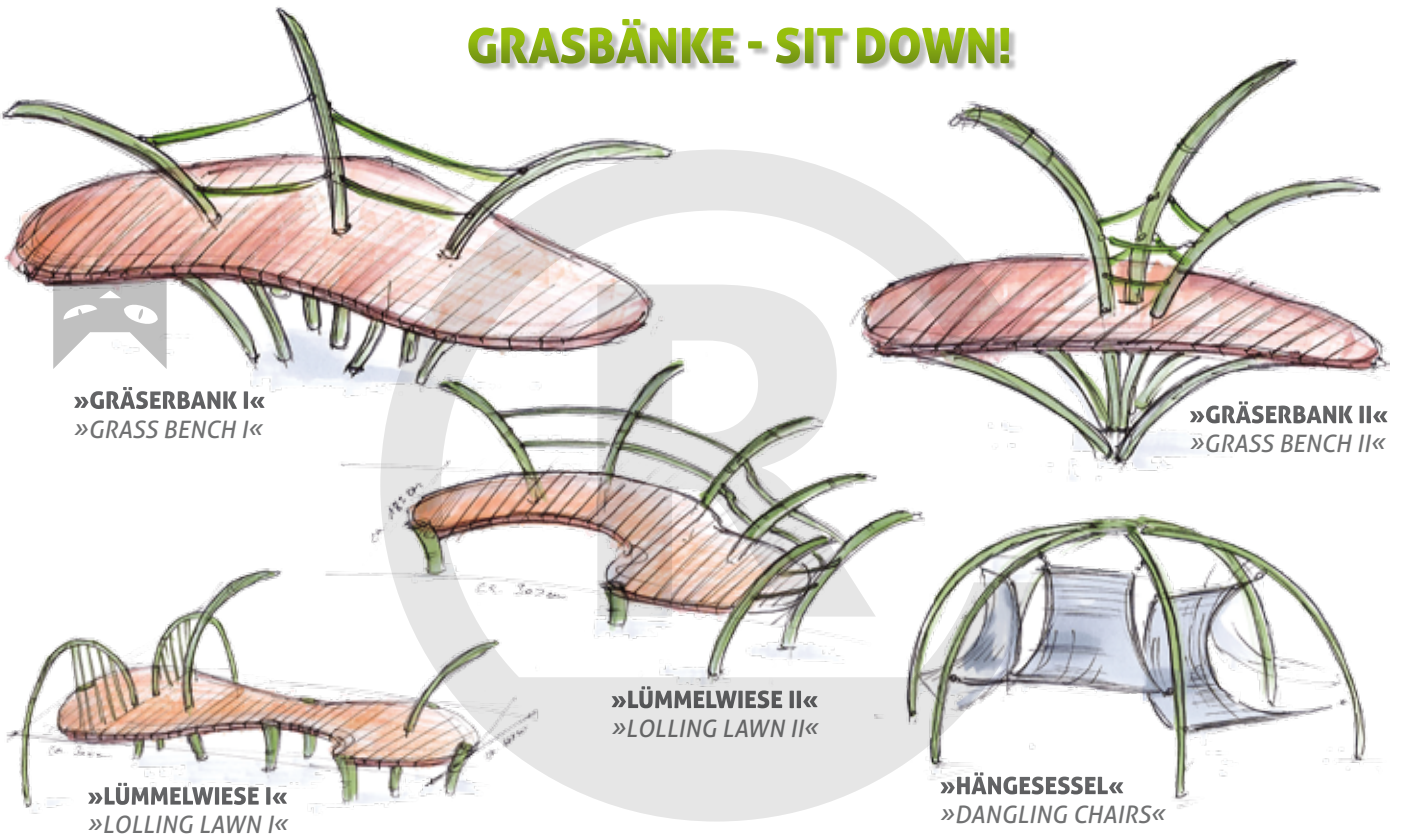

»GRÄSERBANK I«  
»GRASS BENCH I«

»GRÄSERBANK II«  
»GRASS BENCH II«

»LÜMMELWIESE II«  
»LOLLING LAWN II«

»LÜMMELWIESE I«  
»LOLLING LAWN I«

»HÄNGESSEL«  
»DANGLING CHAIRS«

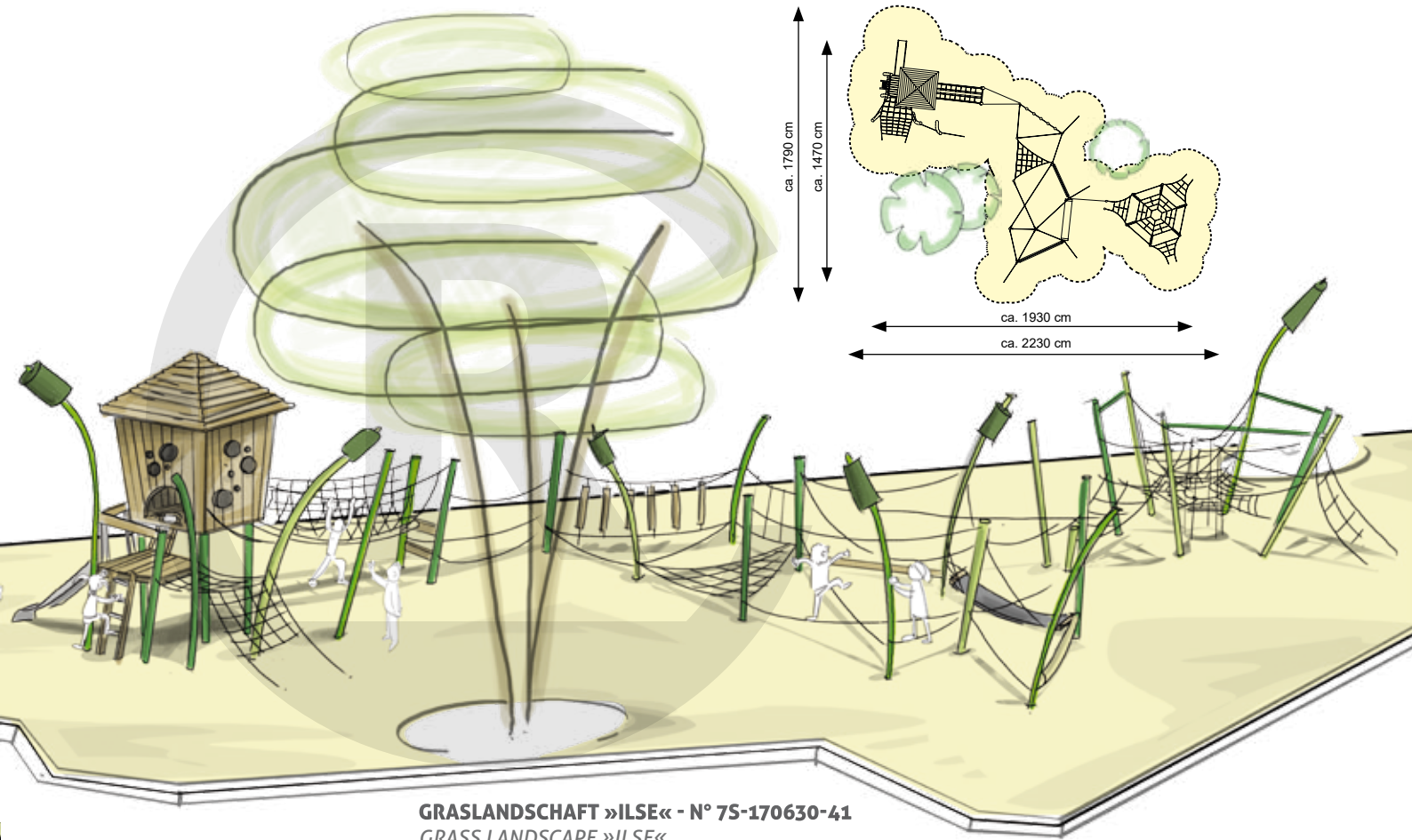

**GRASLANDSCHAFT »ILSE« - N° 7S-170630-41**  
 GRASS LANDSCAPE »ILSE«

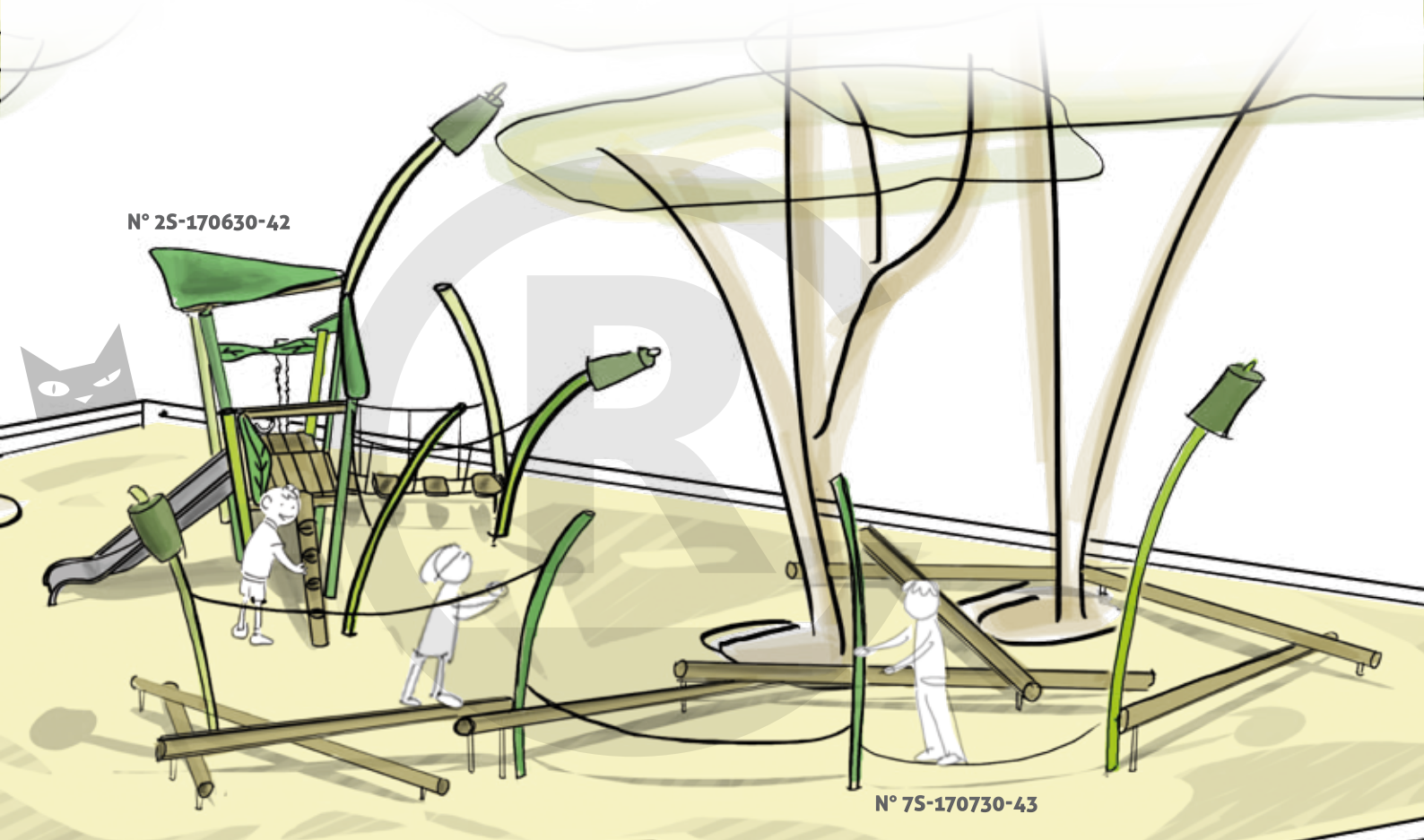

**N° 2S-170630-42**

**N° 7S-170730-43**

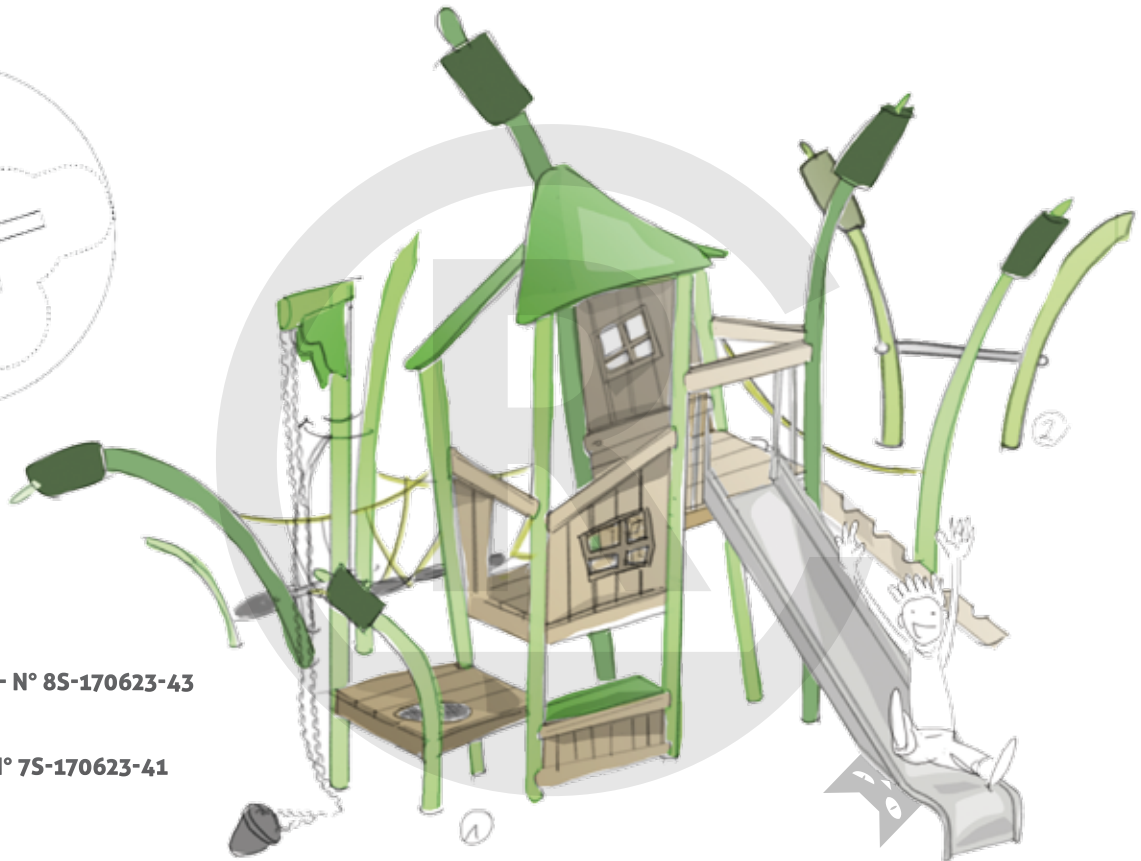
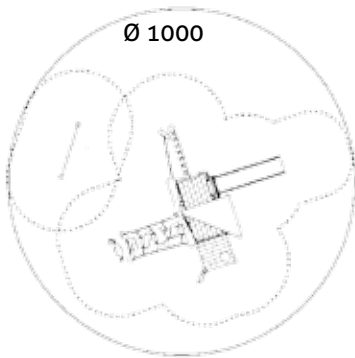

① **GRASHÜTTE »KÖLN«** - N° 8S-170623-43  
GRASS CABIN »KÖLN«

② **»GRASRECKDICH«** - N° 7S-170623-41  
»GRASS BAR «

**SCHAUKEL »WASSERTRÜDINGEN«** N° 6S-170222-44

SWING »WASSERTRÜDINGEN«

- 2 Edelstahl-Standpfosten  
2 posts made of stainless steel
- Edelstahl-Querträger  
horizontal beam made of stainless steel
- 1 Paar Edelstahl-Kettengehänge  
1 pair of swing chains made of stainless steel
- Sicherheitschaukelsitz / safety swing seat

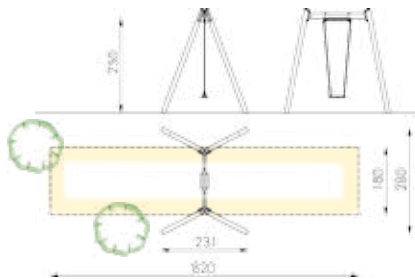

M 1 : 200



PREISLISTE	ALTER	FALLSCHUTZBEREICH	MAX. HÖHE	GEWICHT	MONTAGE	FUNDAMENTE
Price List P.13	Age 3-8	Protective Area 280 x 820 cm	Free Fall 125 cm	Weight 120 kg 45 kg	Field Installation 2 Monteure je 1h	Basement 2 Stck. 80 x 60 x 40 cm

**»JOSEPHSPLATZ 15«** NESTSCHAUKEL - N° 6S-151126-21

»JOSEPHSPLATZ 15« NEST SWING

- 8 gebogene Edelstahl-Standpfosten  
8 curved posts made of stainless steel
- 2 Einpunktlager mit Fangkette  
2 swing pivot points with arresting chain
- Nest, Ø = 90 cm / nest, Ø = 90 cm

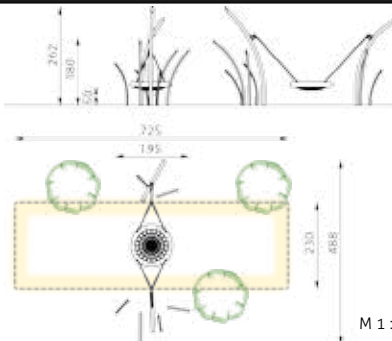

M 1 : 200

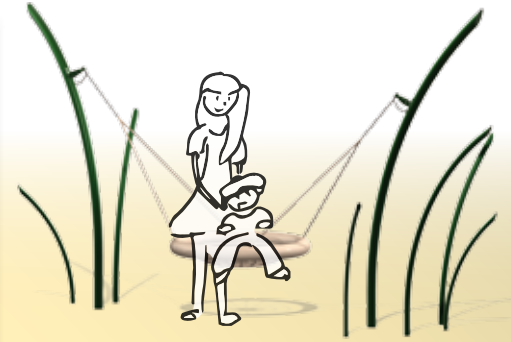

PREISLISTE	ALTER	FALLSCHUTZBEREICH	MAX. HÖHE	GEWICHT	MONTAGE	FUNDAMENTE
Price List P.13	Age 2-12	Protective Area 230 x 725 cm	Free Fall 160 cm	Weight 1000 kg 450 kg	Field Installation 2 Monteure je 3h, Hebezeug	Basement 2 Stck. 140 x 90 x 60 cm



## HÄNGEMATTE »GRÄSER« N° 6.5600-170214-42

### HAMMOCK »GRASS«

2 gebogene Edelstahl-  
Standpfosten  
2 curved posts made of  
stainless steel

2 Kettenwirbel, hochfest  
2 chain rotators, high-  
strenght

Hängematte aus engmaschi-  
gem Herkulestaunetz mit  
Überschlagschutz  
hammock with small meshes  
net made of herkules rope  
with rollover protection

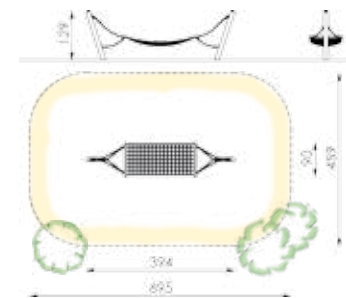

M 1 : 200

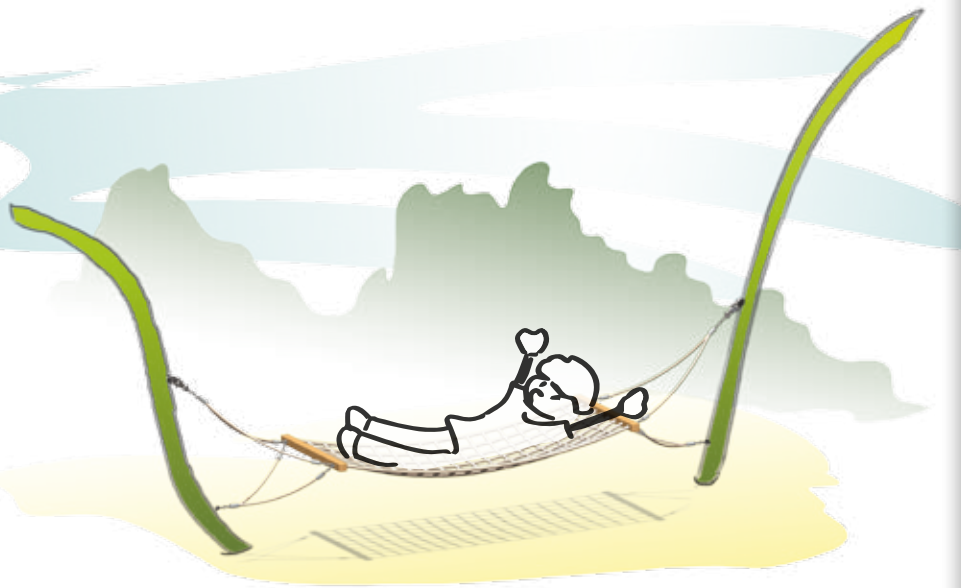

PREISLISTE	FALLSCHUTZBEREICH	MAX. HÖHE	FUNDAMENTE
Price List <b>P.13</b>	Protective Area <b>459 x 695 cm</b>	Free Fall <b>125 cm</b>	Basement <b>2 Stck. 80 x 80 x 60 cm</b>
ALTER	MONTAGE	GEWICHT	
Age <b>3-14</b>	Field Installation <b>2 Monteure je 1h</b>	Weight <b>160 kg / 75 kg</b>	

## »LÜMMELWIESE« - N° 7S-170214-43

### »LÜMMELWIESE«

4 gebogene Edelstahl-  
Standpfosten  
4 curved posts made of  
stainless steel

Flächennetz / horizontal net

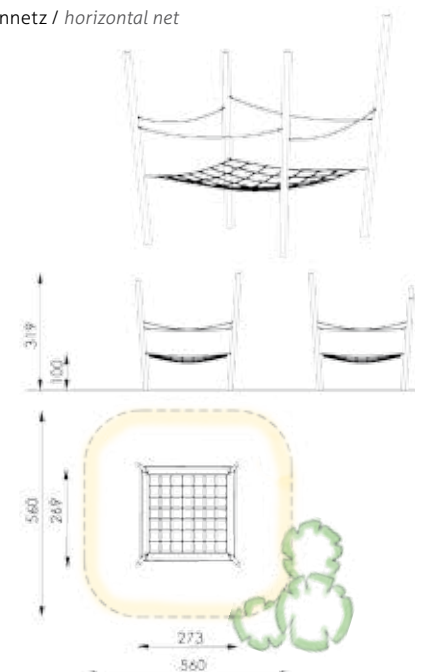

M 1 : 200

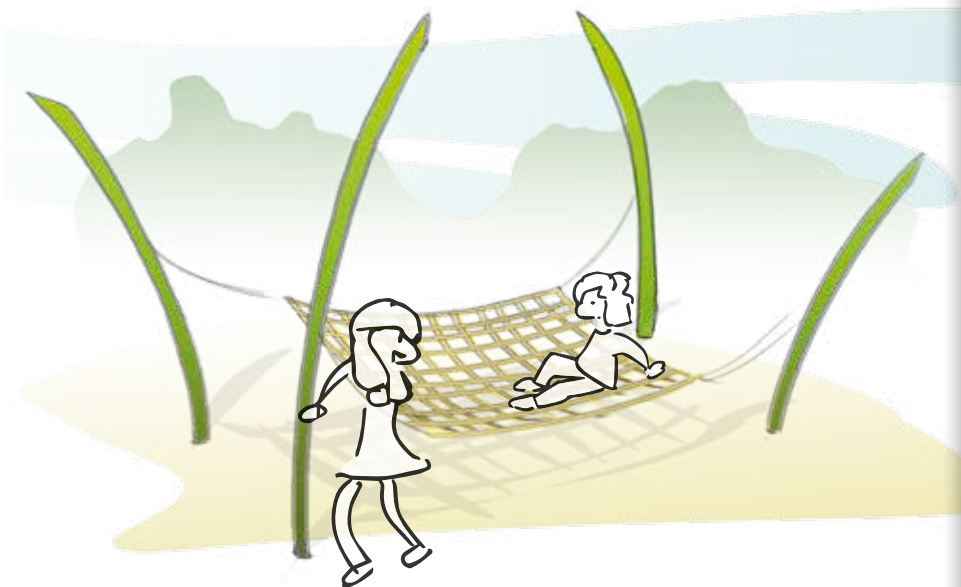

PREISLISTE	FALLSCHUTZBEREICH	MAX. HÖHE	FUNDAMENTE
Price List <b>P.13</b>	Protective Area <b>560 x 560 cm</b>	Free Fall <b>50 cm</b>	Basement <b>4 Stck. 60 x 60 x 40 cm</b>
ALTER	MONTAGE	GEWICHT	
Age <b>2-6</b>	Field Installation <b>2 Monteure je 2,5h</b>	Weight <b>160 kg / 40 kg</b>	



»JOSEPHSPLATZ 9B« - N° 8S-150304-21

»JOSEPHSPLATZ 13« - N° 8S-151016-22



»JOSEPHSPLATZ 3« - N° 8S-141204-26

»JOSEPHSPLATZ 14« - N° 8S-151125-21

»JOSEPHSPLATZ 1B« - N° 8S-151125-21



»GRASSPINNE« - N° 75-170214-41





**BSFH**  
Wir schaffen Spielräume



# SPIEL-BAU GMBH

Alte Weinberge 21 • D-14776 Brandenburg (Germany) • [www.spiel-bau.de](http://www.spiel-bau.de)

+49 (0) 3381 26 14-0 +49 (0) 3381 26 14-18 [spiel-bau@spiel-bau.de](mailto:spiel-bau@spiel-bau.de)

